



---

## **MCI 804LX**

LIGHTING MANAGEMENT MODULE  
12/24 VDC

This installation manual has been written by the manufacturer and it is considered integrating part of this product.

The information included are intended for the expert technicians who execute the installation and the extraordinary maintenance of the product.

The expert technicians must have specific competences and particular abilities in order to carry out correctly and safely their work.

The constant observance of the information included in this manual guarantees safety of men, energy serving and a longer duration of product operative-life.

In order to avoid wrong handling and the consequent risk of accidents, it is important to read this manual carefully, keeping scrupulously to guidelines according to the supplied information.

## CONFORMITY DECLARATION

All the devices of the YACHTICA® system are designed in order to comply the directives:

- EN 60945 Maritime navigation and radiocommunication equipment and system.
- IEC 61000;
- IEC 60068;
- IEC 60695;
- Rules for the Classification of Ship - Part C - Machinery;
- Systems and Fire Protection - Ch. 3, Sec. 6, table 1.

## **TYPE APPROVAL RINA: N° DIP244620CS**

All the devices of the YACHTICA® system are tested and found to comply with the specification of the CE marking.



All brand names, product names and trademarks are property V.Y.C. Srl.  
©2020 V.Y.C. Srl

## CONTENTS

<b>DESCRIPTION</b>	<b>PG 4</b>
<b>FEATURES</b>	<b>PG 5</b>
<b>APPLICATIONS</b>	<b>PG 6</b>
<b>TECHNICAL SPECIFICATIONS</b>	<b>PG 7</b>
<b>MODULE DESCRIPTION</b>	<b>PG 8</b>
<b>DISPLAY DESCRIPTION</b>	<b>PG 13</b>
<b>INSTALLATION</b>	<b>PG 16</b>
<b>WIRING DIAGRAMS</b>	<b>PG 18</b>
<b>PROGRAMMING</b>	<b>PG 23</b>
<b>PROBLEM SOLVING</b>	<b>PG 25</b>
<b>REPAIR AND WARRANTY POLICIES</b>	<b>PG 27</b>

## DESCRIPTION

The MCI 804LX module is equipped with an integrated programmable microcontroller used to control and to dimm 4 different 12/24V<sub>DC</sub> lighting sources.

The module is rated to work with voltage driven monochromatic LEDs (with or without driver added). It can also be used to control 12/24V<sub>DC</sub> incandescent and halogen lamps. Each channel handles up to 16A.

The module has 8 programmable dry contact inputs that can be used with push-buttons or sensors, allowing to create global scenes.

The module can be used in stand-alone mode or connected to other modules of the YACHTICA® system through the use of the BUS system EasyBUS. It can be easily programmed allowing to create global scenes controlled by push-buttons and/or integrated to be controlled by smartphone/tablet or touch screen.

## FEATURES

**4 Dimmer outputs 12/24V<sub>DC</sub>**

Each channel allows a PWM (400Hz default) 12/24V<sub>DC</sub> constant voltage dimming for passive (LED strip), active (spot with electronic on board) or spot with voltage (12/24V<sub>DC</sub>) to current (ex. 350-500-700mA, etc.) dimmable driver lighting sources. It can also be used to control 12/24V<sub>DC</sub> constant voltage halogen light circuits.

**8 Programmable dry contact inputs**

The module allows single output or light scene control using the 8 dry contact inputs where push-buttons or sensors can be connected. The inputs are programmable using the YACHTICA® software Cabot.

**EasyBUS communication**

The module is able to communicate with other devices of the YACHTICA® automation system when connected inside an EasyBUS network. The removable EasyBUS connecting block is used to link the module to the other modules of the same EasyBUS network.

**Cabot programming software**

The module can be programmed, managed and monitored using the YACHTICA® software Cabot.

**Stand-alone mode**

The module has a standard programming that allows to manage outputs and light presets, connecting push-buttons or sensors to the dry contact inputs.

**Short circuit and overload advanced protection**

Each single output is protected by an advanced monitoring system that is able to recognize a short circuit, disabling and protecting the module. The module also has an overload management system that avoid the outputs to be damaged, automatically reducing the outputs percentage value if needed.

**NOTE: the module does not protect the load connected to the outputs. it suggested to protect the outputs properly, according to the project requirements**

**Opto-isolation between electronic and power**

Module electronic power supply and output power are opto-isolated in order to avoid interferences on the outputs.

**Programming, control and monitoring display**

By the use of the display on the front panel it is possible to manage the 4 outputs and set some module parameters.

**DIN rail installation**

The MCI 804LX module can be installed into an electrical switchboard using DIN rail. Once installed and the switchboard closed, the module's front panel, with control buttons and the display, is still accessible.

**Detachable terminal block**

All the terminal block of YACHTICA® modules are detachable, allowing a simple wiring and a quick replacement without the need to disconnect any cable, with a high level of security and stability of the system.

**Tropicalized electronic**

All the YACHTICA® modules have a tropicalization treatment in order to prevent a deterioration due to the humidity and sea mist.

## APPLICATIONS

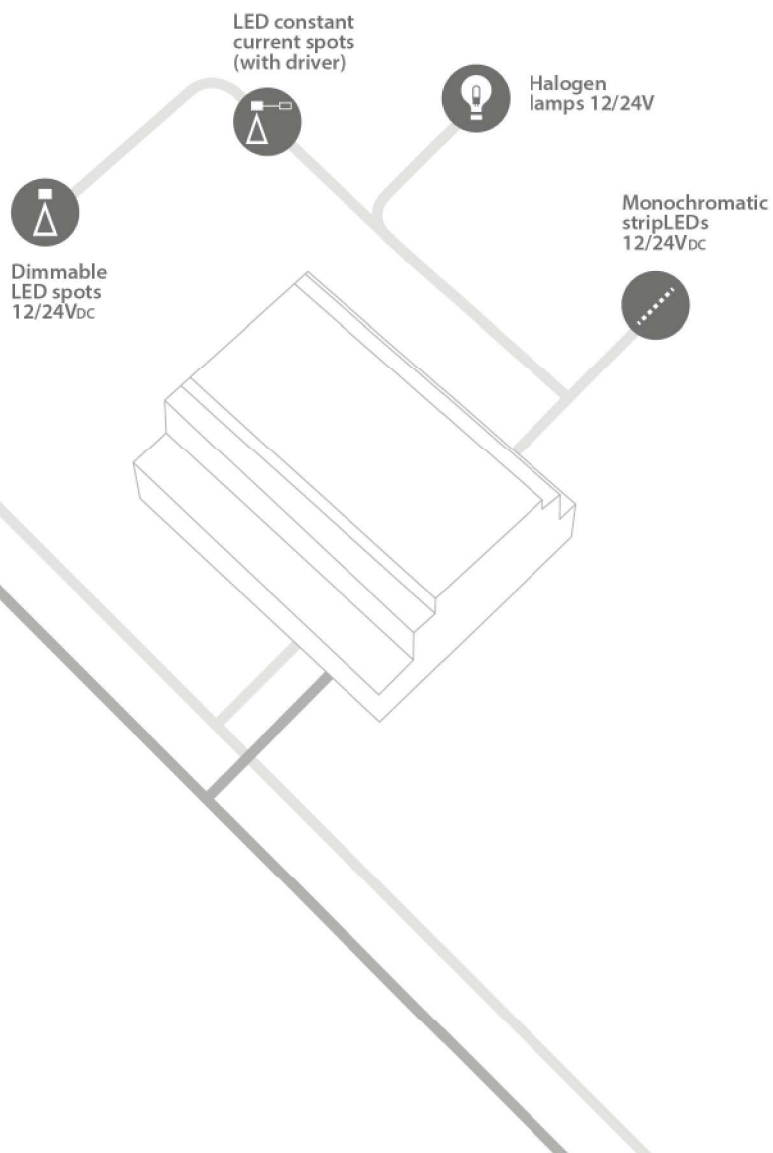

## TECHNICAL SPECIFICATIONS





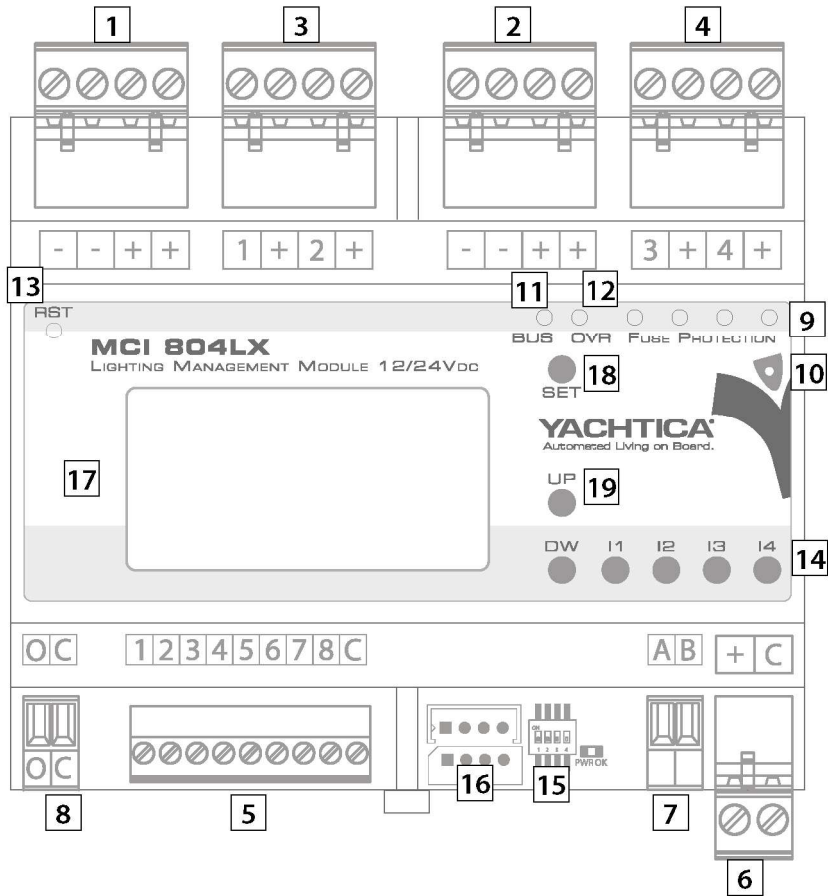

SPECIFICATION	DETAILS
<b>Electronic power supply</b>	11-28V <sub>DC</sub>
<b>Electronic requirements</b>	0,6W (20mA @24V <sub>DC</sub> , 40mA @12V <sub>DC</sub> )
<b>Outputs power supply</b>	12/24V <sub>DC</sub>
<b>Outputs</b>	4
<b>Dry contact inputs</b>	8
<b>Load ratings</b>	-16A@24V (384W) per channel, PWM 400Hz -16A@12V (192W) per channel, PWM 400Hz
<b>Default address</b>	32
<b>Working temperature</b>	+5°/+55° C (41°/131° F)
<b>Storage temperature</b>	-40°/+70° C (-40°/+158° F)
<b>Humidity</b>	15%/90% non condensing
<b>Heat dissipation (@Ta=40°C, maximum load)</b>	6,6W
<b>IP Protection</b>	IP20
<b>Enclosure</b>	Self-extinguishing UL94-V0
<b>Color</b>	RAL 7024
<b>Dimensions (LxHxD)</b>	106x58x90 mm (6 DIN module spaces)
<b>Weight</b>	263 g
<b>Compliance</b>	CE; EN60945; EN61000-4-2; EN61000-4-3; EN61000-4-4; EN61000-4-5; EN61000-4-6; EN61000-4-8; EN61000-4-11; CISPR 16-1-1; EN 60695-11-5; IEC60068-2; IEC60068-6; IEC60068-30; RINA Rules 2018 Pt. C, Ch. 3, Sec.6.





MODULE DESCRIPTION



#	CONNECTORS, LED, INDICATORS	DESCRIPTION
1		<b>4 poles detachable connector;</b> <b>Maximum cable section:</b> 2,5mm <sup>2</sup> (12AWG); Outputs 1-2 power supply connector <sup>(1)</sup> ; -/-: negative 12-24Vdc; +/: positive 12-24Vdc.
2		<b>4 poles detachable connector;</b> <b>Maximum cable section:</b> 2,5mm <sup>2</sup> (12AWG); Outputs 3-4 power supply connector <sup>(1)</sup> ; -/-: negative 12-24Vdc; +/: positive 12-24Vdc.
3		<b>4 poles detachable connector;</b> <b>Maximum cable section:</b> 2,5mm <sup>2</sup> (12AWG); Outputs 1-2 connector; <b>1:</b> output 1 negative/output 1 PWM; <b>++:</b> positive 12-24Vdc outputs 1 & 2; <b>2:</b> output 2 negative/output 2 PWM; <b>++:</b> positive 12-24Vdc outputs 1 & 2.
4		<b>4 poles detachable connector;</b> <b>Maximum cable section:</b> 2,5mm <sup>2</sup> (12AWG); Outputs 3-4 connector; <b>3:</b> output 3 negative/output 3 PWM; <b>++:</b> positive 12-24Vdc outputs 3 & 4; <b>4:</b> output 4 negative/output 4 PWM; <b>++:</b> positive 12-24Vdc outputs 3 & 4.
5		<b>9 poles detachable connector;</b> <b>Maximum cable section:</b> 1,5mm <sup>2</sup> (15AWG); 8 dry contact inputs connector; <b>1-8:</b> inputs; <b>C:</b> common.



#	CONNECTORS, LED, INDICATORS	DESCRIPTION
6		<p><b>2 poles detachable connector;</b>  <b>Maximum cable section:</b> 2,5mm<sup>2</sup> (12AWG);            Electronic power supply connector;            +: positive 11-28Vdc;            -: negative 11-28Vdc.            Be sure that all the negative poles of all the power supplies used for electronic are in parallel.</p> <p><b>NOTE: it is suggested to use a dedicated stabilized power supply for the electronic of all the modules inside a switchboard. It's important that modules installed into different switchboards connected together have negative poles in parallel (the use of YACHTICA® AMP 102D is suggested).</b></p>
7		<p><b>2 poles detachable connector;</b>  <b>Maximum cable section:</b> 1,5mm<sup>2</sup> (15AWG);            EasyBUS connector;  <b>A:</b> BUS A pole;  <b>B:</b> BUS B pole.            Be sure that cabling of BUS connector is consistent for all the modules in the network. This avoid bad working of the system.</p>
8		<p><b>2 poles detachable connector;</b>  <b>Maximum cable section:</b> 1,5mm<sup>2</sup> (15AWG);            Override connector;  <b>O:</b> override contact;  <b>C:</b> common.            In case of short circuit between C and O the module starts Override mode: all the outputs are forced to 100%. The module can't be controlled by the inputs or by Cabot.</p>
9		<p><b>Red LED alert signal on outputs, FUSE PROTECTION.</b>            - LED on: shortcircuit on output;            - LED blinking (1 second frequency): output power supply for corresponding outputs missing (1-2 and 3-4);            - LED blinking (3 pulse per second): overload on corresponding output.</p>
10		<p><b>Blu LED, PWR.</b>            On if electronic power supply is given.</p>
11		<p><b>Orange LED, BUS.</b>  <i>IFD Blinking:</i> the module is connected to other modules in an EasyBUS network and is not the master module. Blinking frequency depends on the address of the module;  <i>LED On:</i> the module could be the master of an EasyBUS network or could fail to communicate with the rest of the network<sup>(2)</sup>.</p>

#	CONNECTORS, LED, INDICATORS	DESCRIPTION
12		<p><b>Orange LED, OVR.</b>            On if the module is in Override mode.</p>
13		<p><b>Recessed button to reset microcontroller of the module, RST.</b>            The outputs will be switched off and the values of outputs and memories will be set to factory values.</p>
14		<p><b>Buttons used to control the corresponding output, following "Dimmer without memory" function<sup>(3)</sup>.</b></p>
15		<p><b>DIP switches to set some standard programming.</b>            DIP switch 4 not used.  <b>000-</b>: the module uses the programming downloaded on the microcontroller.            Following DIP switches settings causes programming downloaded on microcontroller stop working.  <b>101-</b>: standard programming<sup>(3)</sup>.  <b>100-</b>: OUT2 linked to OUT1. Outputs 1 and 2 are driven by I1 in parallel, I2 is not used. I3 and I4 are used to control the corresponding outputs.  <b>110-</b>: OUT2 and OUT3 are linked to OUT1. Outputs 1, 2 and 3 are driven by I1 in parallel, I2 and I3 are not used. I4 is used to control the corresponding output.  <b>111-</b>: OUT2, OUT3 and OUT4 are linked to OUT1. Outputs 1, 2, 3 and 4 are driven by I1 in parallel, I2, I3 and I4 are not used.  <b>010-</b>: OUT3 is linked to OUT2. Outputs 2 and 3 are driven by I2 in parallel, I3 is not used. I1 and I4 are used to control corresponding outputs.  <b>011-</b>: OUT3 and OUT4 are linked to OUT2. Outputs 2, 3 and 4 are driven by I2 in parallel, I3 and I4 are not used. I1 is used to control the corresponding output.  <b>001-</b>: OUT2 is linked to OUT1 and OUT4 is linked to OUT3. Outputs 1 and 2 are driven by I1 in parallel, I2 is not used; Outputs 3 and 4 are driven by I3 in parallel, I4 is not used.</p>
16		<p><b>4 poles connector<sup>(4)</sup> to manage the module</b> (or the whole system) using the YACHTICA® MBC ETH o ICB 101X modules (not included).</p>

## DISPLAY DESCRIPTION

## INTRODUCTION



The module is equipped with a top board with a display and buttons for the setting and the management of some parameters without the needed of YACHTICA® software Cabot. Following the description of each screen with its features.

Use UP and DW buttons to scroll between the pages if the module is not in SETTING mode.

To enter in SETTING mode of the page displayed and set its parameters, keep pressed the SET button for 5 seconds. The first parameter will blink and it will be possible to use UP & DW buttons to choose the desired value. Once the value is set, press shortly SET buttons to pass to the next parameter.

To exit from SETTING mode keep press the SET button for 5 seconds or wait for 10 seconds until the blinking parameter stops.

Even in SETTING mode the buttons to control the outputs work.

#	CONNECTORS, LED, INDICATORS	DESCRIPTION
17		<b>Programming, monitoring and control display.</b> Control display allows to set some basic parameters of the module and to monitor the outputs status.
18		<b>Setup button, SET.</b> If pressed for 5s put the module in SETTING mode, allowing to set some parameters. If pressed for 5s while it is in setting mode it exit from it. In SETTING mode if short pressed scroll between the settable parameters.
19		<b>Up and Down buttons, UP &amp; DW.</b> Scrolling buttons for display pages if not in SETTING mode. If the module is in SETTING mode they are used to set some internal parameters.

<sup>(1)</sup> Using alternate tension causes modules to be damaged.





<sup>(2)</sup> See PROBLEM SOLVING paragraph.

<sup>(3)</sup> See STANDARD PROGRAMMING paragraph.

<sup>(4)</sup> Contact YACHTICA® to receive the dedicated interface cable to be used.

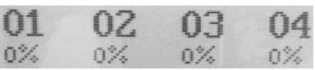
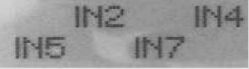
### PAGE 1: Control screen

From this page is possible to see the 4 outputs status (by the percentage displayed) and the 8 inputs status. In SETTING mode it will be possible to set the address and the max address as well. In this page some alert icons are present.

#	LABEL, ICON	DESCRIPTION
1		<b>Outputs percentage.</b> Show the percentage of each output.
2		<b>Inputs status.</b> If an input is activated, a corresponding label will be shown on the display.
3		<b>Outputs 1-2 and 3-4 power supply.</b> Show if a 12/24Vdc is present on the outputs 1-2 (on the left) and 3-4 (on the right). If the icon is not present, the corresponding couple of red FUSE LEDs on the front panel starts to blink according to the specification described in the previous section.
4		<b>Address module, ADR.</b> Address of the module. The value is settable between 1 and MAX-1. If the module is in SETTING mode, use UP & DW buttons to select the desired address. The default value is 32.
5		<b>Max net address, MAX.</b> Higher address of the modules inside the net (add 1 to this address is suggested). If the module is in SETTING mode, use UP & DW buttons to select the max value desired. The default value is 33.  <b>NOTE: a module cannot communicate with other modules of the same net if its address is higher than the MAX of the others (see Cabot manual).</b>

### PAGE 2: Output mode

From this page is possible to set the outputs function mode: NORMAL or REVERSE. Setting the right one allows to sync the value of the output in case a LED lighting source with 3 wires driver (with 3rd cable used for PWM) are used. In case the circuit is ON while the corresponding output is at 0% (or viceversa) it means that the LED circuit works on REVERSE mode (or viceversa).

Keep pressed SET button for 5 seconds to enter in SETTING mode of the first output. Use UP & DW buttons to choose between the two mode. Press shortly SET button to scroll to the next outputs.  
Keep pressed SET button for 5 second or wait for 10 seconds to exit from SETTING mode.

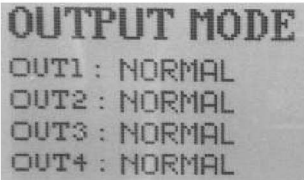
#	LABEL, ICON	DESCRIPTION
1		<b>Output mode, NORMAL/REVERSE.</b> For each output is indicated the corresponding output function mode.

### PAGE 3: Module information

This page shows the hardware and software version of the module.

#	LABEL, ICON	DESCRIPTION
1		<b>HARDWARE &amp; SOFTWARE VERSION.</b> Product hardware and software version.



## INSTALLATION

### Important notes

The following information are intended for the expert technicians who execute the installation and the extraordinary maintenance of the product. The installation and the maintenance of the module must be executed by qualified technicians, respecting the Norm of the installation country.

The expert technicians must have specific competences and particular abilities in order to carry out correctly and safely their work.

The constant observance of the information included in this manual guarantees safety of men, energy saving and a longer duration of product operative-life. Keep this manual and notes included.

In order to avoid wrong handling and the consequent risk of accidents, it is important to read this manual carefully, keeping scrupulously to guidelines according to the supplied information.

Electrical tension may cause shock and severe burns. Be sure to turn off the electrical supply before carrying out any type of work on the connectors. Omission of observation of these safety measures may cause death or severe lesions to people as well as great material damages.

Before preceeding with the use of the modules, make sure that electric installation, carried out by a qualified technician in conformity with the Technical Norms, corresponding to the class of homologation of the electrical system, is provided with the devices prescribed for the protection against direct and indirect contacts and electrical surcharges.

The modules of the YACHTICA® must be exclusively used in connection with other modules and external components which are conformed to the Norms comparative to the product.

Do not use the module if, upon visual inspection, it shows deterioration of the enclosing box or if the screening wraps of the feeding cables show any wear and tear or damage.

The YACHTICA® system may not be used to carry out safety and accident prevention functions since it does not have the redundancy requirements lawfully requested.

The installer must verify the correct installation and operation of the product.  
It is prohibited to use the product for improper purposes or purposes different from those provided

V.Y.C. Srl shall not be held liable for any damage of any sort or kind in case of module used or installed incorrectly.

It is prohibited to tamper or to modify the product.

### Before starting

Place the module inside a switchboard and follow carefully the following wiring diagrams. The module can be installed on DIN rail.

Always switch off the electronic and outputs power supply before carrying out any type of electrical connection on the module.

**NOTE: use a dedicated stabilized power supply for electronic modules installed into a switchboard. If into an EasyBUS network more than one power supply is used (for instance, one power supply for each switchboard containing YACHTICA® modules) be sure that all the negative poles of all the power supplies are in parallel (it is suggested to use YACHTICA® AMP 102D).**

The module is intended for internal use. Install it in dry place in order to respect the specifications described in the TECHNICAL SPECIFICATIONS paragraph of this manual.

### Blackout management

The YACHTICA® modules manage the states of lack of power supply both for the electronic and the power in case of dimming modules.

#### Lack of electronic power supply (all modules).

In case of lack of this tension the module switch off. After the blackout the outputs come back to their latest values before the blackout.

#### Lack of power supply for outputs (dimmer modules).

In case of lack of power supply for the outputs, the dimmer modules show this with a blinking of FUSE PROTECTION LED and the lighting icons on the display will disappear. After the blackout, if no problem occurs, the outputs come back to their latest values.

### Addressing

Each YACHTICA® module placed into an EasyBUS network must have a unic address. The default address for all YACHTICA® modules is 32 and Max Address 33. Before connect the BUS connectors of more modules in the same net, be sure that they have a different address. It is possible to address the module using the display.

It is possible to change the address of a module using the YACHTICA® programming software Cabot.

**NOTE: a madule cannot communicate with other modules in the same net if its Address is upper than the Max Address of the others (see Cabot manual).**

## WIRING DIAGRAMS

Shown below different wiring diagrams that can be used when installing a MCI 804LX module.

**NOTE:** all the YACHTICA® modules installed in an EasyBUS network must have the negative pole of electronic power supply in parallel. If this specification is not verified unexpected behaviour of the system can happen.

**NOTE:** it is not possible to wire an EasyBUS network in a ring. If this specification is not verified unexpected behaviour of the system can happen.

To link different switchboards with YACHTICA® modules inside it is suggested to use AMP 102D module.

For particular wiring ask for YACHTICA® assistance.

**WARNING:** it is suggested to protect each output with a fuse according to the wiring used. Sizing the protection according to the wires used and to the load connected to them.

**CAUTION:** verify carefully that the terminal blocks are fully insert in their position and that the wires are fully insert in their position and screwed correctly. Any wrong wiring, considering the high rate of currents running in the module, could cause an excessive overheating. It is suggested to protect the power input section in order to avoid any loop of current due to wrong wiring in the field, not monitored by the module itself.

**WARNING:** do not use the terminal blocks PWR A and PWR B as a junctions to other links. Such wiring can involve an overcurrent on the first terminal block.

**CAUTION:** the terminal block are tested and certified for use with flexible or rigid cord. The component builder does not contemplate the use of tips whose use is the responsibility of the installer. In this case it is recommended the utmost attention in the crimping that must be uniform on all 4 sides to avoid the creation of contact tips.

**NOTE:** since important currents are circulating inside the module, it is advisable, prior to the delivery of the plant, to check with a thermal gun the overheating state of the module in order to immediately highlight any anomalies external loads or incorrect connections.

**NOTE:** it is suggested to protect each output properly (fuse), according to the wiring present on board. Choose proper size of protections according to the section of the cables used and according to the load connected.

## SCHEME 1: Direct wiring on the module

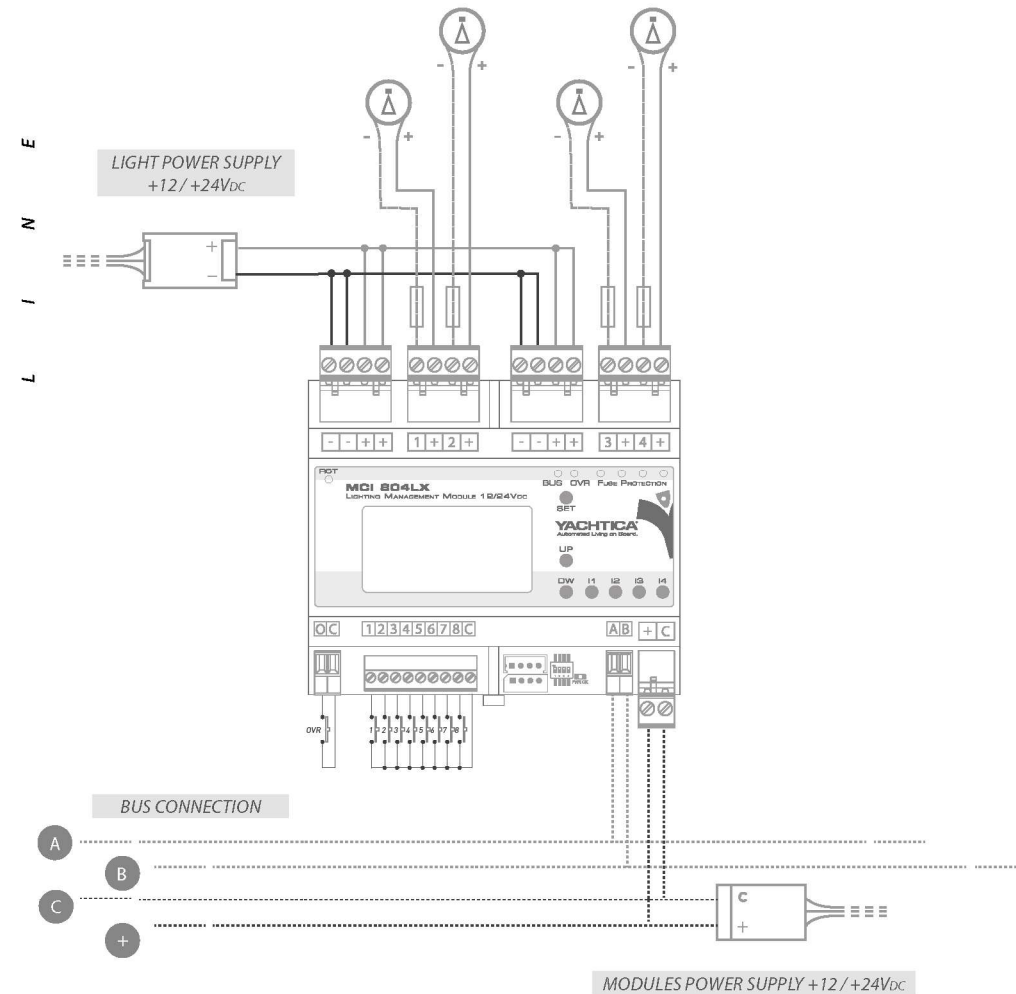



### SCHEMA 2: Wiring with direct positive

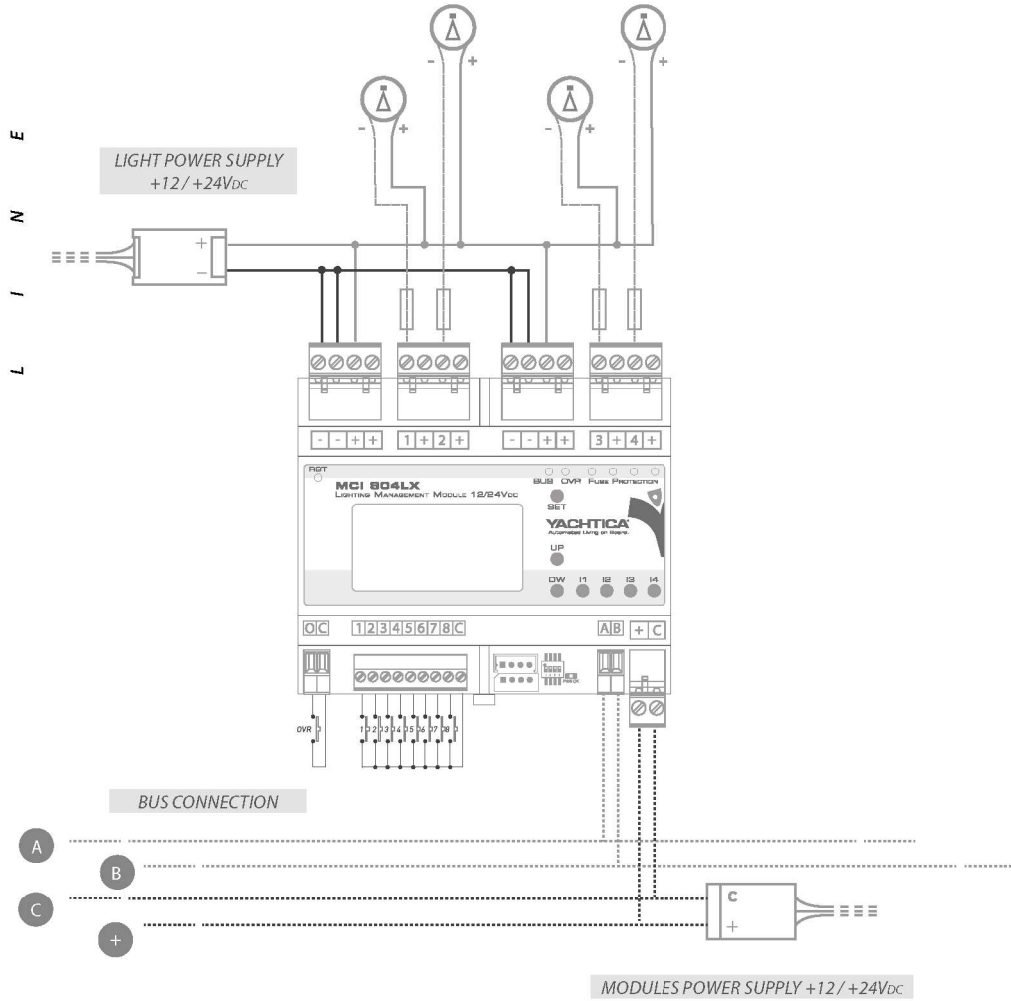

### SCHEMA 3: Wiring with direct positive and independent power supply

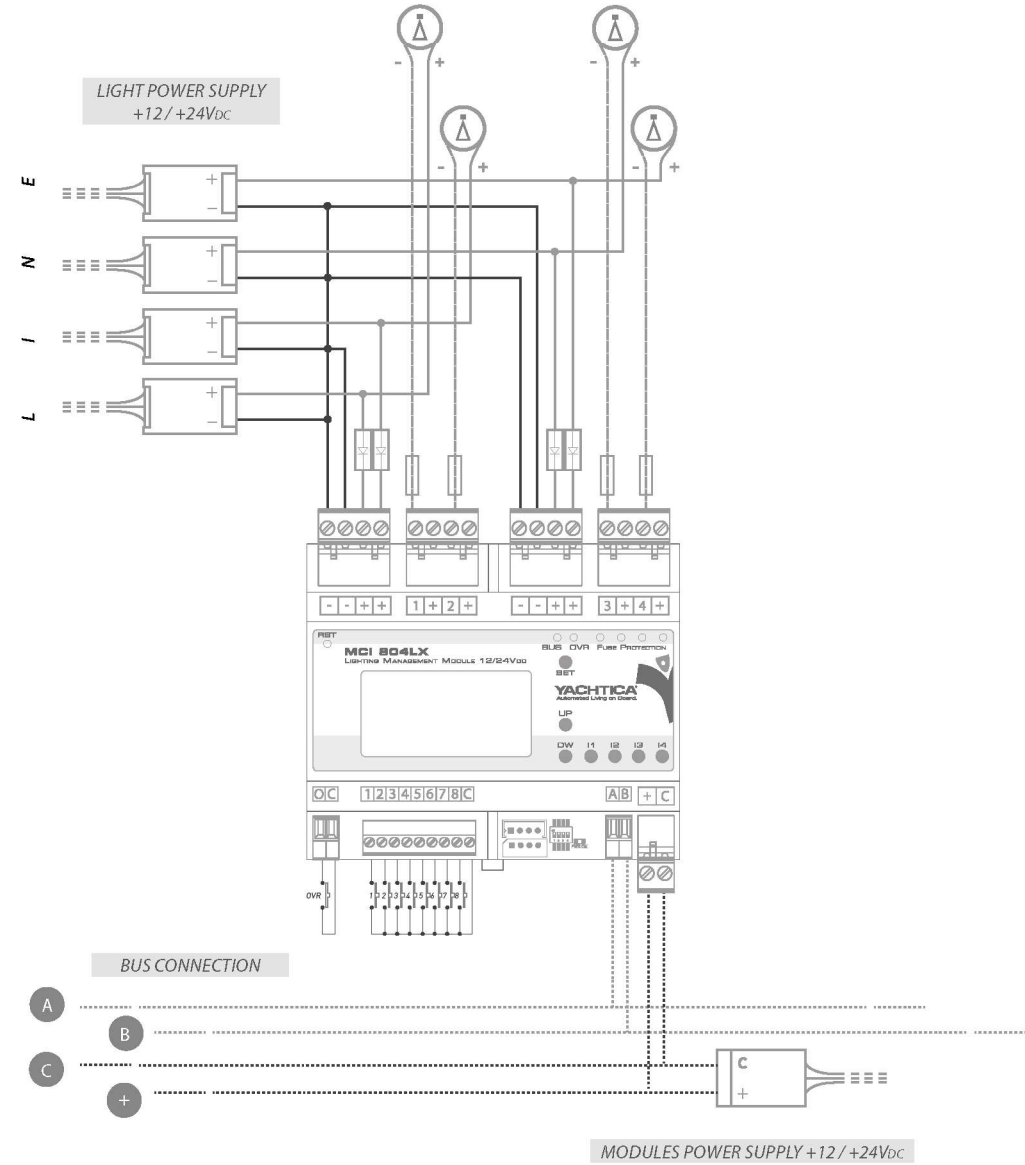

## SCHEME 4: Wiring for 3 wires spots

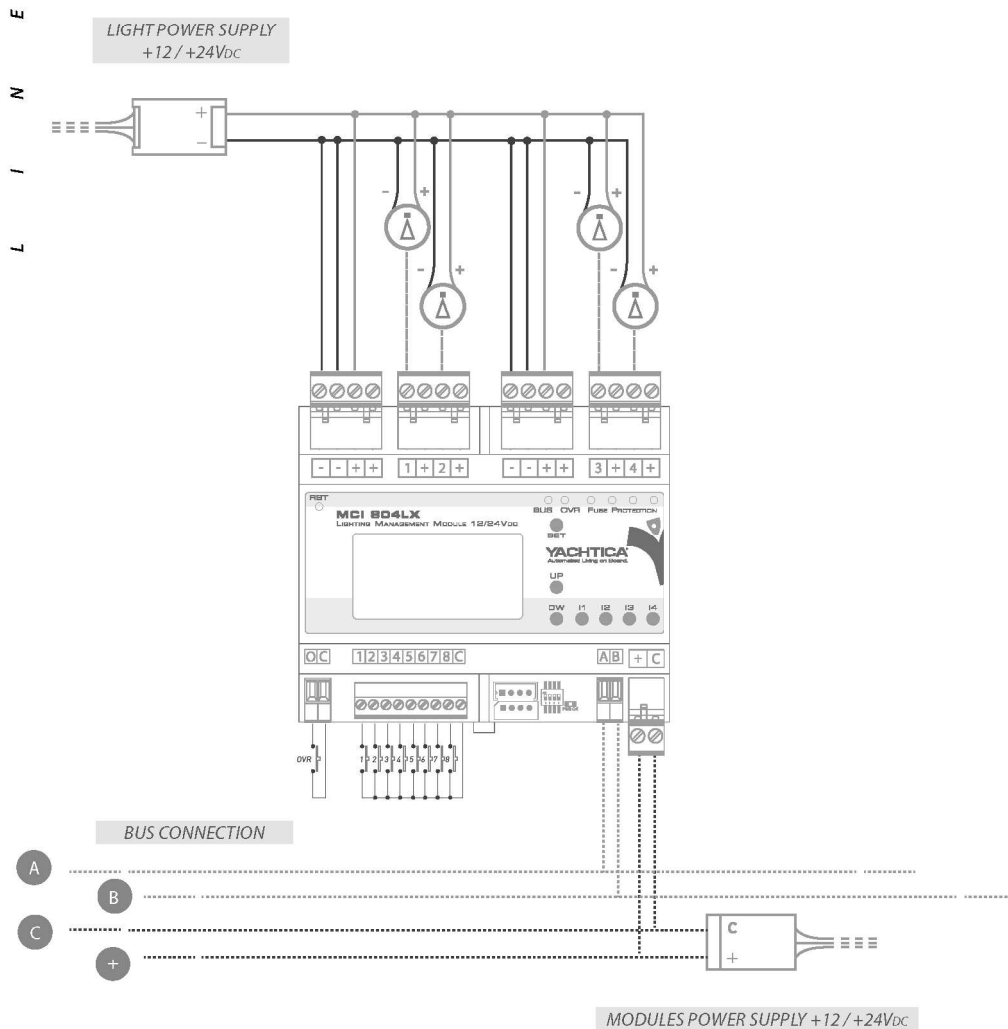

## PROGRAMMING

## STANDARD PROGRAMMING

Each MCI 804LX module has a standard programming that allows it to be used with its 8 dry contact inputs. Each input is associated with a particular functionality. The functionalities of the inputs can be tested using Cabot. According to the setting of the DIP switches it is possible to select some particular programming usable with the 8 dry contact inputs.

## NOTE

The 4 buttons on the top board do the Dimmer without memory function: long press does the dimming of the output; short press switch on and off the output at 100% with a ramp. The memory of the value reached with a long press is lost.

## CONFIGURATION 000-: CUSTOM PROGRAMMING

If the DIP switches are in this configuration, the module executes the custom programming created with YACHTICA® Cabot software.

## OTHER CONFIGURATIONS: STANDARD PROGRAMMING

If one of the possible configurations of the DIP switches is set, a simple link between the outputs is configured, keeping the same functionalities of the 8 dry contact inputs (see table pg 11).

# IN	FUNCTION NAME	DESCRIPTION
1-2-3-4	<b>Dimmer With Memory</b>	4 Outputs control commands: - <b>Short press:</b> switch on and off corresponding output to its last value, in 3 seconds. - <b>Long press:</b> allows the dimming of the corresponding output. When reaching 100% and 0%, the dimming process stops for 2 seconds, in order to select these particular values. When releasing the button the output stops to the reached value.
5	<b>All On Scene</b>	Command for a 4 outputs scene control. - <b>Short press:</b> switch on and off the outputs to 100% in 3 seconds. - <b>Long press:</b> allows the dimming of the 4 outputs. The outputs start dimming to low values, getting synchronized when reaching 0%, then raising towards 100% values.
6	<b>Welcome Scene</b>	Command used to set 4 outputs to 60% in 3 seconds.
7	<b>Night Scene</b>	Command used to set 4 outputs to 20% in 3 seconds.
8	<b>All Off Scene</b>	Command used to set 4 outputs to 0% in 2 seconds.

## PROBLEM SOLVING

**Programming with Cabot**

The module can be programmed using the YACHTICA® software Cabot. Read the manual of the software for all the information needed about Cabot and the module programming.

For programming examples surf the link [www.yachtica.com](http://www.yachtica.com)

For advanced programming requested contact YACHTICA® technical department if needed.

PROBLEM	POSSIBLE CAUSE	POSSIBLE SOLUTION
<b>Module does not switch on</b>	The module doesn't receive power supply on the electronic power supply connector	Check that dedicated power supply is working properly, providing right output voltage according to the specifications written in this manual.
	Positive and negative cabling poles inverted	Check that dedicated power supply positive and negative poles are connected in the right way.
<b>The module is switched on but the outputs connected don't switch on</b>	The module doesn't receive output power supply ( <b>Red fuse LED blinking once per second</b> ).	Check that 12/24V <sub>DC</sub> dedicated output power supply is working properly, providing right output voltage.
	One or more outputs are in short circuit ( <b>Red fuse LED on for corresponding output</b> ).	Check the cabling for the outputs. There's a short circuit on the output corresponding to the fuse LED switched on.
	One or more outputs are in overload ( <b>Red fuse LED blinking 3 times per second for corresponding output</b> )	Check that the load connected to each output of the module is under 16A. Check also that the switchboard temperature in which the module is installed is not too high: hot places can reduce the maximum load of the outputs.
<b>The module has the BUS LED always on but its address is not the lowest used in the network</b>	The module has address higher than the MAX ADR of the module with lowest address in the network	Check the MAX ADR value of the module with lowest address in the network. Set the address of the module according to that value.
	Communication BUS card damaged	Communication BUS card needs to be replaced (ask help to YACHTICA® technicians).
	Problem on the BUS cable	Check the cabling of all the BUS chains connected to the same loop of the module. Short circuit or inversion on A-B poles can be present.

PROBLEM	POSSIBLE CAUSE	POSSIBLE SOLUTION
<b>Nothing happens while pressing a button connected to an input of the module</b>	The module is in Override mode	Check that OVR input is not activated.
	The input has no functionality programmed	Use Cabot software to check the programming of the module, in particular for the not working input.
	Broken cable problem	Check that while pressing the button the corresponding label on the display is switched on. Check cabling in case it doesn't happen.
<b>One or more outputs floats between two different intensity level</b>	Overload problem <b>(Red fuse LED blinking 3 times per second for corresponding output)</b>	Check the power load connected to the output and be sure that it is under the max load rating of the module. Check also the switchboard temperature where the module is installed, being sure it's not too high for best performance of the module.

## REPAIR AND WARRANTY POLICIES

### Merchandise returns

No V.Y.C. Srl merchandise may be returned for credit, exchange or service without prior authorization from V.Y.C. Srl. To obtain warranty service for V.Y.C. Srl products, contact V.Y.C. Srl or an authorized dealer. Request for an RMA (Return Merchandise Authorization) and fill it in properly all the fields, before returning the module. Shipments arriving freight collect or without RMA number shall be subject to refusal.

Return freight charges following repair of items under warranty shall be paid by V.Y.C. Srl, shipping by standard ground carrier. In the event repairs are found to be non-warranty, return freight costs shall be paid by the purchaser. V.Y.C. Srl will provide repairing costs in case the merchandise is not under warranty.

### V.Y.C. Srl limited warranty

V.Y.C. Srl warrants YACHTICA® products to be free from manufacturing defects in materials and workmanship under normal use for a period of 2 years from the date of purchase.

This warranty extends to products purchased directly from V.Y.C. Srl or an authorized YACHTICA® dealer.

V.Y.C. Srl shall not be liable to honor the terms of warranty if the product has been used in any application other than that for which it was intended or if it has been subject to misuse, accidental damage, modification or improper installation procedures

Furthermore, this warranty does not cover any products that has had the warranty void label altered, defaced or removed.

V.Y.C. Srl shall, at its option, repair or replace any product found defective, without charge for parts or labor. Repaired or replaced equipment and parts supplied under this warranty shall be covered only by the unexpired portion of the warranty.

Except as expressly set forth in this warranty, V.Y.C. Srl makes no other warranties, expressed or implied, nor authorizes any other party to offer any warranty, including any implied warranties of merchantability or fitness for a particular purpose. Any implied warranties that may be imposed by law are limited to the terms of this limited warranty.

This warranty statement supersedes all previous warranties.



[www.yachtica.com](http://www.yachtica.com)

V.Y.C. Srl reserve the rights to change the specification and data herewith without a notice.  
© 2020 by V.Y.C. Srl - All Rights Reserved.