

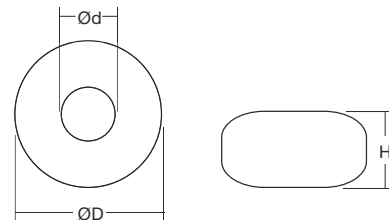

Trasformatori Toroidali
Marini
Standard Classe I

Marine Toroidal
Transformers
Class I Standard



Articolo Article	Potenza Power VA	Tensione Voltage (in/out) V	Protezione Protection	Dimensioni Dimension			Peso Weight gr.	Omologazioni Approvals
				Ød	ØD	H		
MTT 50-12	50	220/12	PTC	23	68	45	700	△△
MTT 50-24	50	220/24	PTC	23	68	45	700	△△
MTT 100-12	100	220/12	PTC	35	96	39	1130	△△
MTT 100-24	100	220/24	PTC	35	96	39	1130	△△
MTT 150-12	150	220/12	TA	35	98	45	1500	△△
MTT 150-24	150	220/24	TA	35	98	45	1500	△△
MTT 200-12	200	220/12	TA	45	115	45	1990	△△
MTT 200-24	200	220/24	TA	45	115	45	1990	△△
MTT 250-12	250	220/12	TA	43	118	48	2100	
MTT 250-24	250	220/24	TA	43	118	48	2100	
MTT 400-12	400	220/12	TA	40	132	57	3600	
MTT 400-24	400	220/24	TA	40	132	57	3600	
MTT 500-12	500	220/12	TA	40	133	68	4100	
MTT 500-24	500	220/24	TA	40	133	68	4100	

- Trasformatori da incorporare IP00.
- Classe termica di isolamento B = 120°C.

- IP00 transformers for integrated installation.
- Thermal insulation class B = 120°C.

- Eventuali potenze e tensioni speciali su richiesta.
- Special power and voltage on request.

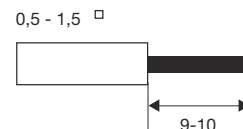

Dati tecnici

Norme di riferimento	EN 61558; EN 61558-2-6
Tensione	220 V - 12 V 220 V - 24 V
Frequenza	0/50...60 Hz
Potenza	50 ÷ 500 VA

Technical data

Reference Norms	EN 61558; EN 61558-2-6
Voltage	220 V - 12 V 220 V - 24 V
Frequency	0/50...60 Hz
Power	50 ÷ 500 VA

Accessori Accessories



Accessori per Trasformatori Toroidali

Accessories for Toroidal Transformers

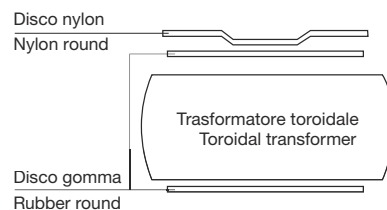

Disco nylon / Nylon round

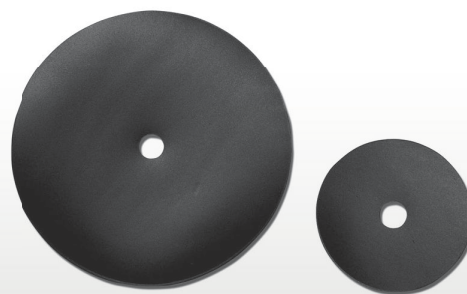

Disco gomma / Rubber round

Descrizione
Description
Interruttore a 3 posizioni ON-OFF-ON, assemblato - Three position switch (ON-OFF-ON), assembled
Porta fusibile assemblato - Fuse holder with fuse, assembled
Disco nylon fibra di vetro Ø60 (ø6,5mm) - Fiberglass-nylon round disc Ø60 (ø6,5mm)
Disco nylon fibra di vetro Ø60 (ø10,5mm) - Fiberglass-nylon round disc Ø60 (ø10,5mm)
Disco nylon fibra di vetro Ø80 (ø10,5mm) - Fiberglass-nylon round disc Ø80 (ø10,5mm)
Disco nylon fibra di vetro Ø90 (ø10,5mm) - Fiberglass-nylon round disc Ø90 (ø10,5mm)
Disco nylon fibra di vetro Ø110 (ø10,5mm) - Fiberglass-nylon round disc Ø110 (ø10,5mm)
Disco nylon UL Ø100 (ø37mm) - UL nylon round disc Ø100 (ø37mm)
Disco di gomma Ø60 - Rubber round disc Ø60
Disco di gomma Ø80 - Rubber round disc Ø80
Disco di gomma Ø90 - Rubber round disc Ø90
Disco di gomma Ø110 - Rubber round disc Ø110
Disco di ferro Ø50 - Iron round disc Ø50
Disco di ferro Ø60 - Iron round disc Ø60
Disco di ferro Ø78 - Iron round disc Ø78
Disco di ferro Ø90 - Iron round disc Ø90
Disco di ferro Ø110 - Iron round disc Ø110
Disco di ferro Ø130 - Iron round disc Ø130

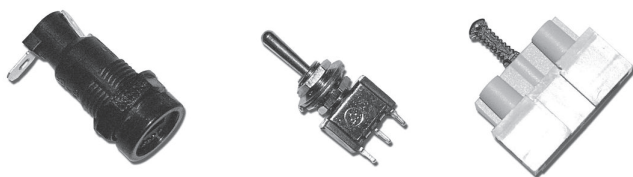

Interruttori e portafusibile / Switch and fuse holder

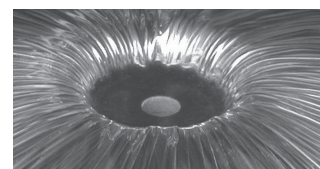

Su richiesta fissaggio tramite resinatura epossidica.
Resin-bonded for fixing on request.

Accessori Accessories



Accessori per
Trasformatori Toroidali

Accessories for
Toroidal Transformers



Contenitore di ferro HIB - H2B / Iron box HIB - H2B

Descrizione Description
HIN Nero (100÷250 W) - Black (100÷250 W)
HICR Cromato (100÷250 W) - Chromate (100÷250 W)
HIB Bianco (100÷250 W) - White (100÷250 W)
H2N Nero (300÷400 W) - Black (300÷500 W)
H2CR Cromato (300÷400 W) - Chromate (300÷500 W)
H2B Bianco (300÷400 W) - White (300÷500 W)

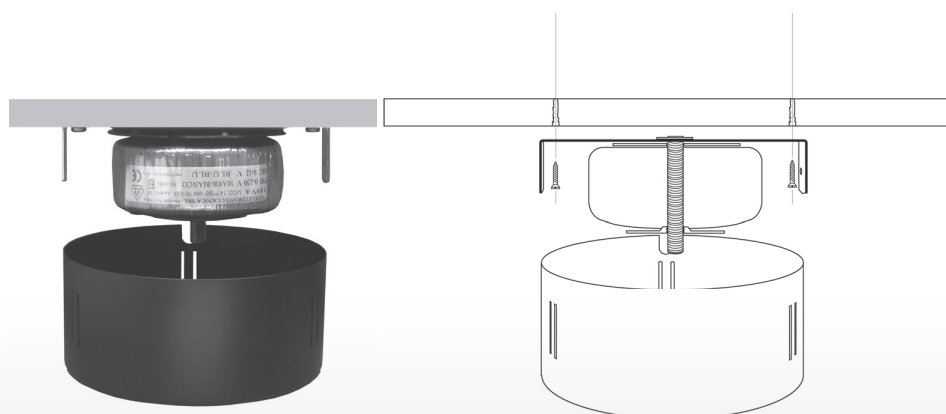

Contenitore di ferro HIN - H2N / Iron box HIN - H2N